

COMBE (Left)

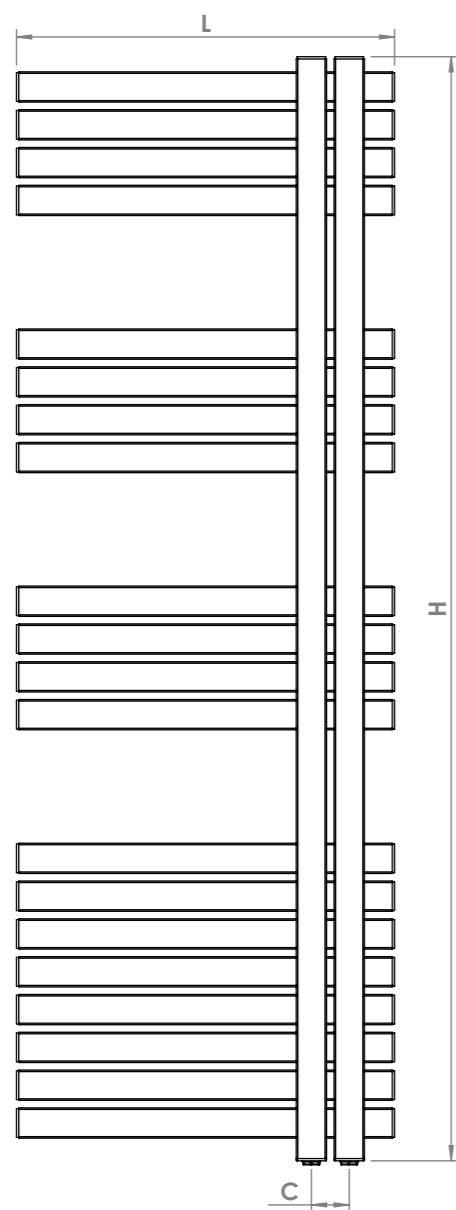

Front View

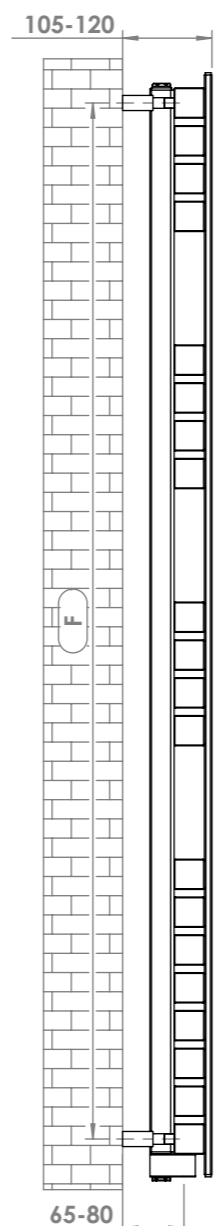

Side View

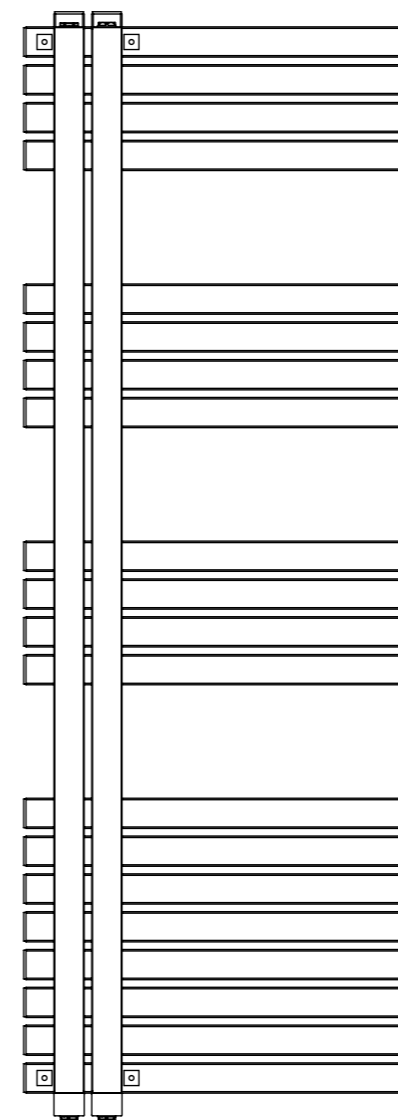

Back View

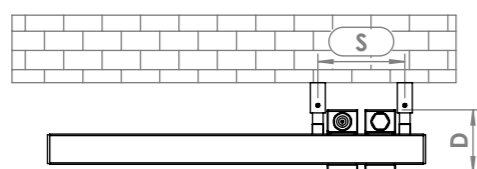
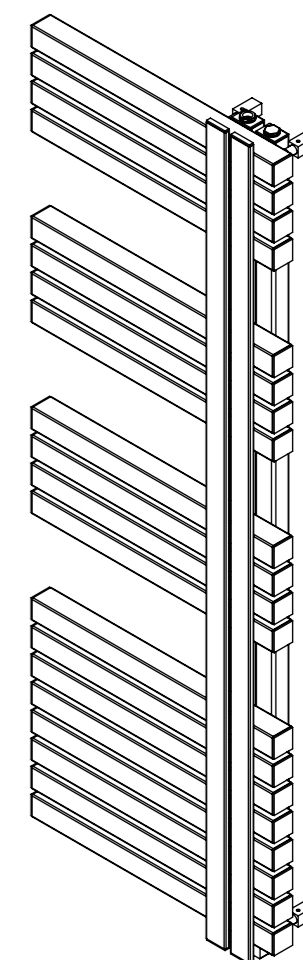



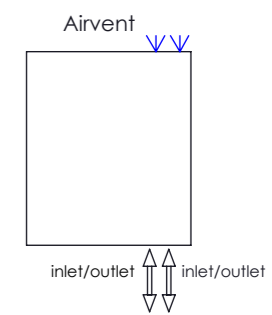

Top View

Plumbing Position:

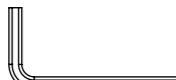

Installation Accessories:

-  x4
-  x4
-  x4
-  x4
-  x4
-  x1

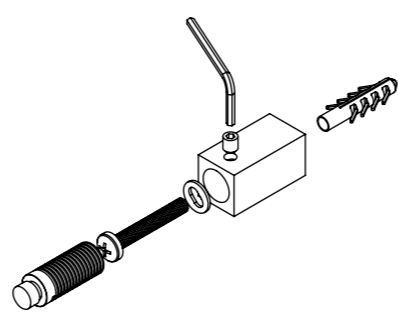

Vertical mount
 All Dimensions are in mm
 Max.Working Pressure: 10 Bar
 Max.Working Temperature: 95° C
 Inlet / Outlet : 1/2" BSP
 Fuel : E/H/D
 Manufacturing Tolerance : - 5 mm

PRODUCT CODE	Height	Length	Depth	Pipe Centres	Bracket Centres	
	H mm	L mm	D mm	C mm	F mm	S mm
COM10-L	920	500	80	50	830	115
COM15-L	1460	500	80	50	1370	115
COM18-L	1710	500	80	50	880-740	115