

Front View

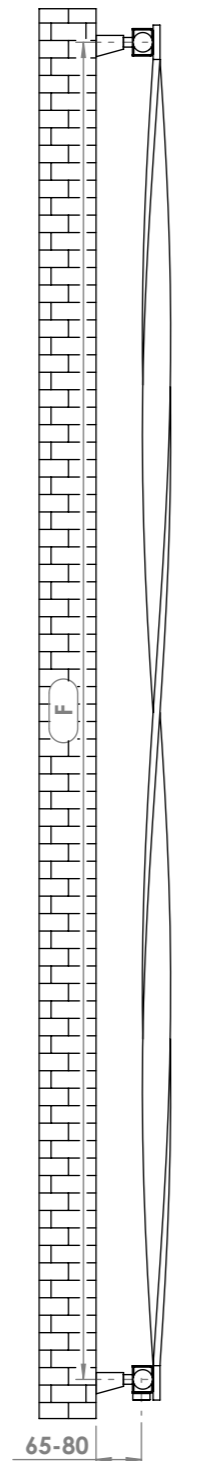

Side View

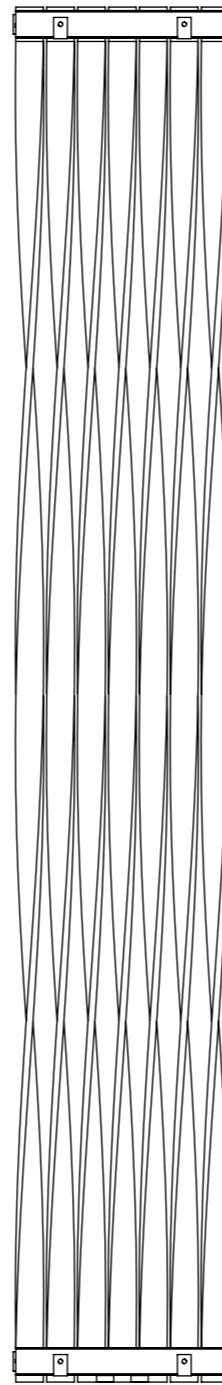

Back View

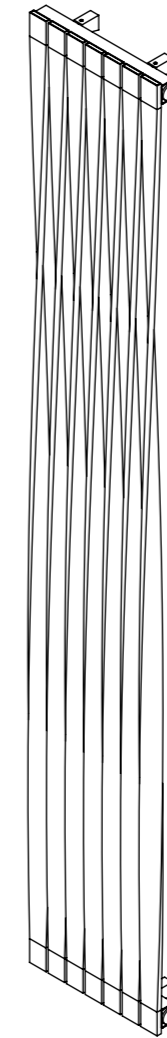

Twister 180°

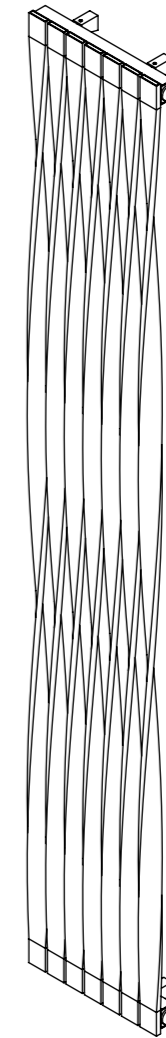

Twister 360°

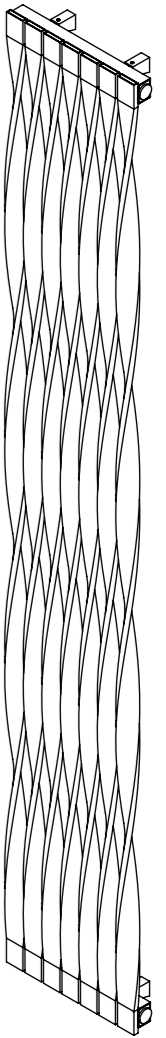

Twister 720°

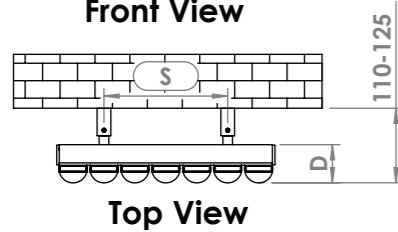

Top View

**Installation Accessories:**

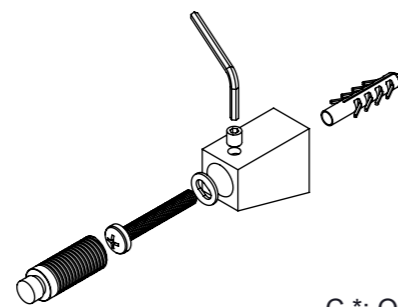
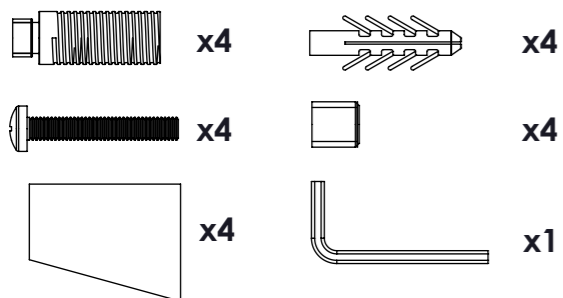

Vertical mount  
 All Dimensions are in mm  
 Max.Working Pressure: 8 Bar  
 Max.Working Temperature: 95° C  
 Inlet / Outlet : 1/2" BSP  
 Fuel : E/H/D

C\* : Only available for mininum seven profiles  
 Manufacturing Tolerance : - 5 mm

When mounting vertically, please observe that the collector fitted with a flow diverter is mounted at the bottom. This can be verified by visually checking or by referring to the installation diagram

**Plumbing Position: Vertical**

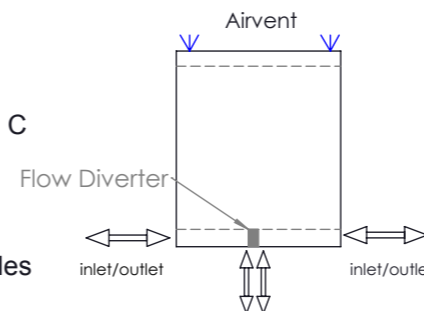

PRODUCT CODE	Height	Length	Depth	Pipe Centres	Bracket Centres	
	H mm	L mm	D mm	C1-C mm	F mm	S mm
TW1505_z180	1500	220	55	50	1445	90
TW1505_z360	1500	220	55	50	1445	90
TW1507_z180	1500	310	55	50-400	1445	180
TW1507_z360	1500	310	55	50-400	1445	180
TW1509_z180	1500	400	55	50-490	1445	270
TW1509_z360	1500	400	55	50-490	1445	270
TW1805_z180	1800	220	55	50	1745	90
TW1805_z360	1800	220	55	50	1745	90
TW1807_z180	1800	310	55	50-400	1745	180
TW1807_z360	1800	310	55	50-400	1745	180
TW1809_z180	1800	400	55	50-490	1745	270
TW1809_z360	1800	400	55	50-490	1745	270
TW2005_z180	2000	220	55	50	1945	90
TW2005_z360	2000	220	55	50	1945	90
TW2005_z720	2000	220	55	50	1940	90
TW2007_z180	2000	310	55	50-400	1945	180
TW2007_z360	2000	310	55	50-400	1945	180
TW2007_z720	2000	310	55	50-400	1940	180
TW2009_z180	2000	400	55	50-490	1945	270
TW2009_z360	2000	400	55	50-490	1945	270
TW2009_z720	2000	400	55	50-490	1940	270