

Features

- Includes face plate with handle.
- Single handle provides on/off activation and volume control.
- Supplied with ADA compliant metal lever handle.
- Complements the Purist® faucet and accessory collections.

Material

- Premium material construction with metal handle ensures reliability and durability.
- KOHLER finishes resist corrosion and tarnishing, exceeding industry durability standards.

Installation

- Trim set requires valve to complete installation.
- Patented K-joint installation technology ensures consistent trim appearance, regardless of variability in valve rough-in.

Required Accessories

K-2977-K 3/4" Volume Control Valve

or

K-2974-K 1/2" Volume Control Valve



ADA CSA B651 OBC

Codes/Standards







ASME A112.18.1/CSA B125.1
ADA
ICC/ANSI A117.1
CSA B651
OBC

KOHLER® Faucet Lifetime Limited Warranty

See website for detailed warranty information.

Available Color/Finishes

Color tiles intended for reference only.

Color	Code	Description
	CP	Polished Chrome
	SN	Vibrant® Polished Nickel
	BGD	Vibrant® Moderne Brushed Gold
	BN	Vibrant® Brushed Nickel
	BV	Vibrant® Brushed Bronze
	BL	Matte Black

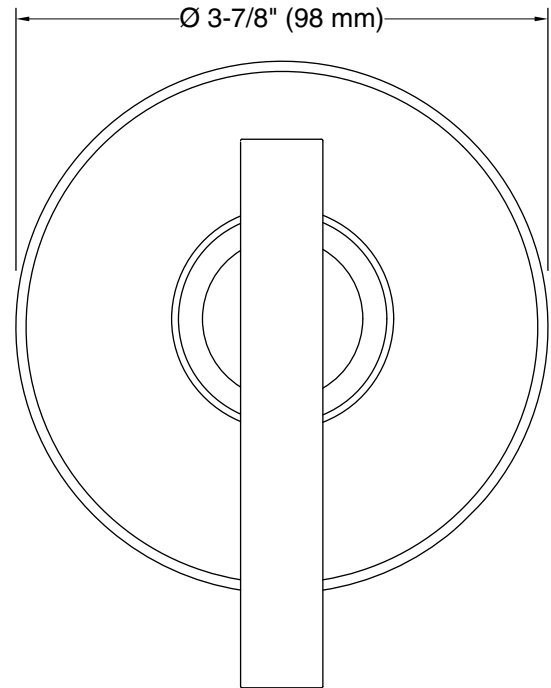
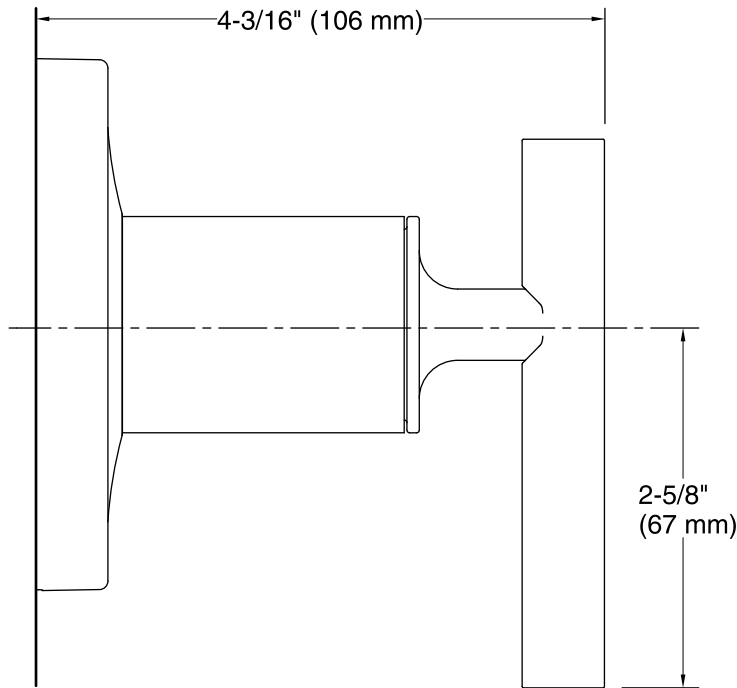

Technical Information

All product dimensions are nominal.

Notes

Install this product according to the installation instructions.

ADA, OBC, CSA B651 compliant when installed to the specific requirements of these regulations.