

# CLIPPER

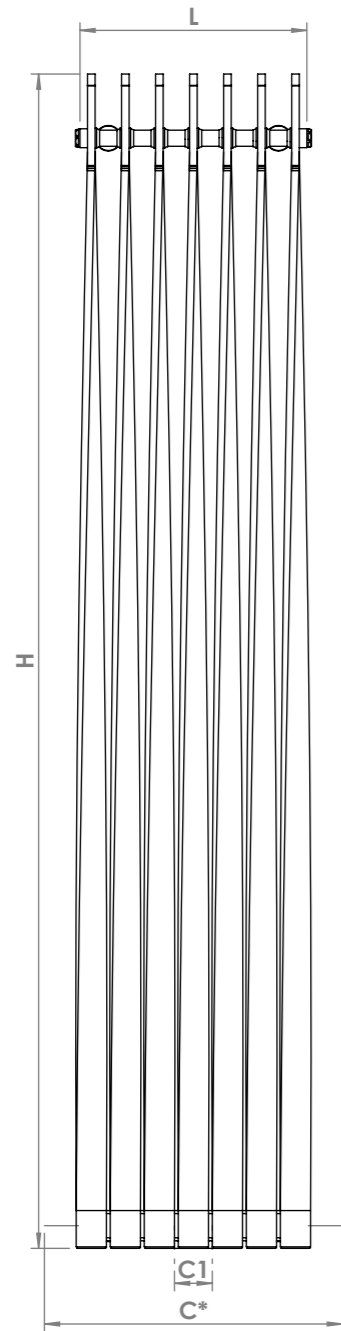

Front View

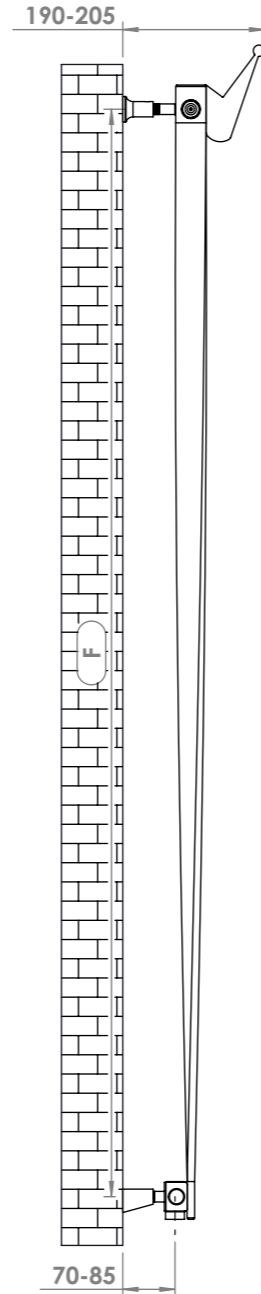

Side View

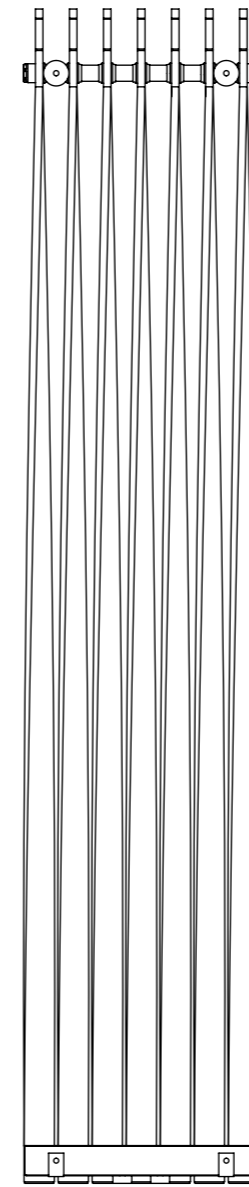

Back View

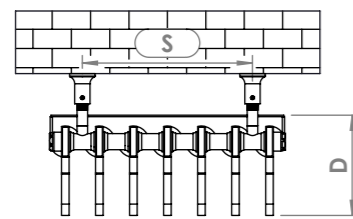
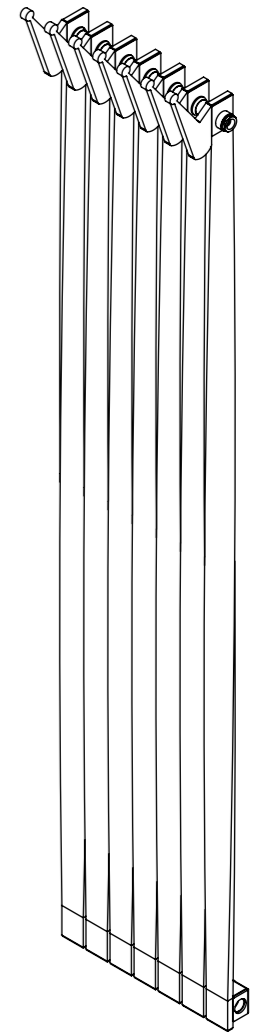

Top View

## Plumbing Position:

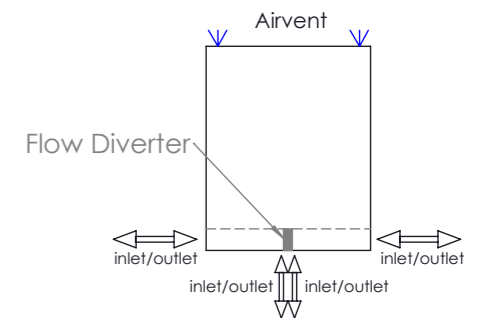

Vertical mount  
 All Dimensions are in mm  
 Max. Working Pressure: 10 Bar  
 Max. Working Temperature: 95° C  
 Inlet / Outlet : 1/2" BSP  
 Fuel : E/H/D

## Installation Accessories:

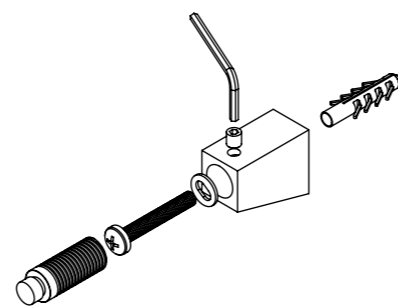
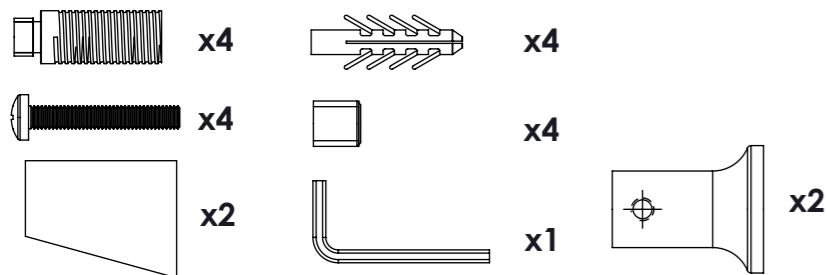

Bottom Bracket

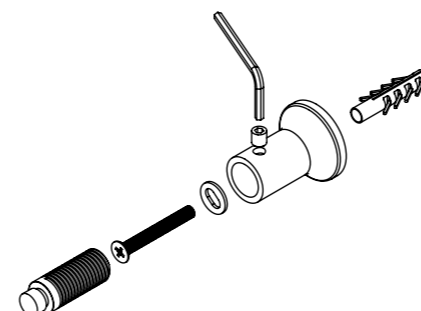

Top Bracket

When mounting vertically, please observe that the collector fitted with a flow diverter is mounted at the bottom. This can be verified by visually checking or by referring to the installation diagram

C \* : Only available for minimum Five profiles

Manufacturing Tolerance : - 5 mm

PRODUCT CODE	Height	Length	Depth	Pipe Centres	Bracket Centres	
	H	L	D	C1-C	F	S
	mm	mm	mm	mm	mm	mm
CL1505	1500	220	130	50	1438	225
CL1507	1500	310	130	50-400	1438	225
CL1509	1500	400	130	50-490	1438	225